

## OPERATION MANUAL SPLIT TYPE ROOM AIR CONDITIONER



AS25TAEHRA-CLC	AS50TDMHRA-C
AS25TADHRA-CLC	AS68TEMHRA-C
AS35TADHRA-CLC	AS68TDRHRA-C
AS50TDDHRA-CLC	AS25TAEHRA(M)
AS68TEDHRA-CLC	AS35TAEHRA(M)
AS68TDRHRA-CLC	AS25TAEHRA-3
AS25TAEHRA-THC	AS35TADHRA-3
AS35TAEHRA-THC	AS50TDDHRA-3
AS50TDDHRA-THC	AS68TDRHRA-3
AS68TEDHRA-THC	AS35TAMHRA-TC
AS68TDRHRA-THC	AS25RHBHRA
AS25TADHRA-THC	AS35RHBHRA
AS35TADHRA-THC	AS50RCBHRA
AS25THMHRA-C	AS68RDAHRA
AS35TAMHRA-C	AS25RHBHRA-M
	AS35RHBHRA-M

- Please read this operation manual before using the air conditioner. Keep this operation manual for future reference. This appliance is filled with R32.



English

Español

Italiano

Français

Deutsch

Português

POLSKI

Češky

ΕΜΗΝΙΚΑ

HRVATSKI

Български

Nederlands



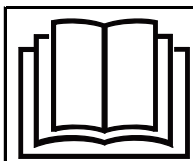

Read the precautions in this manual carefully before operating the unit.



This appliance is filled with R32.

Keep this manual where the user can easily find it.

## WARNING:

- Do not use means to accelerate the defrosting process or to clean, other than those recommended by the manufacturer.
- The appliance must be stored in a room without continuously operating ignition sources (for example: open flames, an operating gas appliance or an operating electric heater).
- Do not pierce or burn.
- Be aware that refrigerants may not contain an odour.
- The appliance must be installed, operated and stored in a room with a floor area larger than 3 m<sup>2</sup>.
- If the supply cord is damaged, it must be replaced by the manufacturer, its service agent or similarly qualified persons in order to avoid a hazard.
- This appliance can be used by children aged 8 years and above and persons with reduced physical, sensory or mental capabilities or lack of experience and knowledge if they have been given supervision or instruction concerning use of the appliance in a safe way and understand the hazards involved. Children shall not play with the appliance. Cleaning and user maintenance shall not be made by children without supervision.
- The wiring method should be in line with the local wiring standard.
- All the cables shall have got the European authentication certificate. During installation, when the connecting cables break off, it must be assured that the grounding wire is the last one to be broken off. The explosion-proof breaker of the air conditioner should be all-pole switch. Distance between its two contacts should not be no less than 3mm. Such means for disconnection must be incorporated in the wiring.
- Make sure installation is done according to local wiring regulation by professional persons.
- Make sure ground connection is correct and reliable.  
A leakage explosion-proof breaker must be installed.
- Do not use a refrigerant other than the one indicated on the outdoor unit(R32) when installing, moving or repairing. Using other refrigerants may cause trouble or damage to the unit, and personal injury.
- The type of connecting wire is H07RN-F.

## Contents

PARTS AND FUNCTIONS .....	1
OPERATION .....	3
INDOOR UNIT INSTALLATION .....	7
MAINTENANCE .....	10
CAUTIONS .....	11
TROUBLE SHOOTING .....	12

# Parts and Functions

## Wi-Fi function description

The system architecture diagram

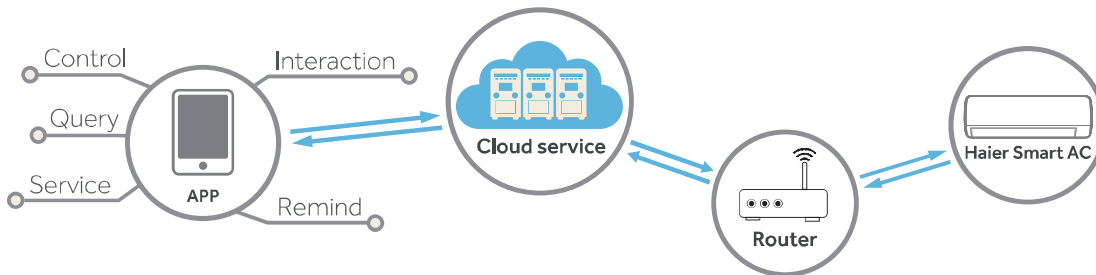

English

The application environment

Smart mobile phone and wireless router are necessary for the application.  
Wireless router must be able to connect to the Internet.  
Smart mobile phone requires IOS or Android system:



IOS system  
must support IOS 9.0 or above



Android system  
must support Android 5.0 or above

Configuration method

Scan the QR code below to download "hOn" APP.  
Other Download options: Please search hOn APP on:

- App Store (IOS)
- Google Play (Android)
- Huawei AppGallery (Android)

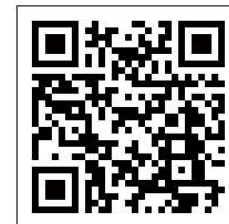

After App Download, please register, connect the air conditioner and enjoy using hOn to manage your device. Please refer to the HELP section inside the APP for more details about how to register, connect the unit, and other operations.

# Parts and Functions

## Indoor Unit

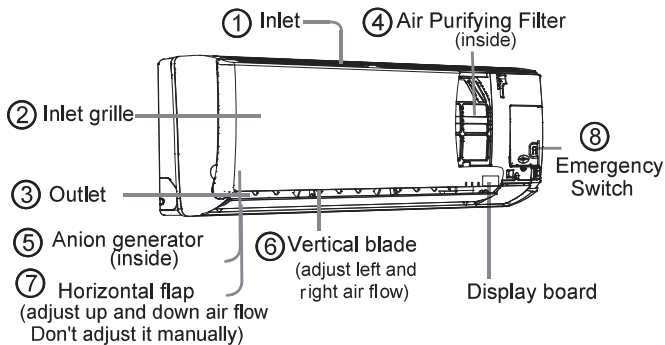

### Display board

- 1 Signal receiver
- 2 Setting temp.display

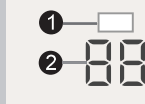

### Display board

- 1 Signal receiver
- 2 Setting temp.display
- 3 Operation mode indicator (lights up when the compressor is on.)
- 4 Wi-Fi



Actual inlet grille may vary from the one shown in the manual according to the product purchased

## Outdoor Unit

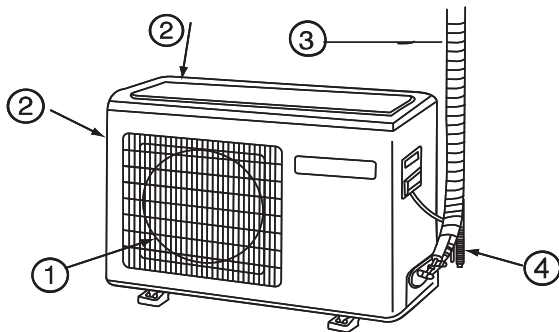

- 1 INLET
- 2 OUTLET
- 3 CONNECTING PIPING AND ELECTRICAL WIRING
- 4 DRAIN HOSE

Please be subject to the actual produce purchased the above picture is just from your reference

## Remote controller

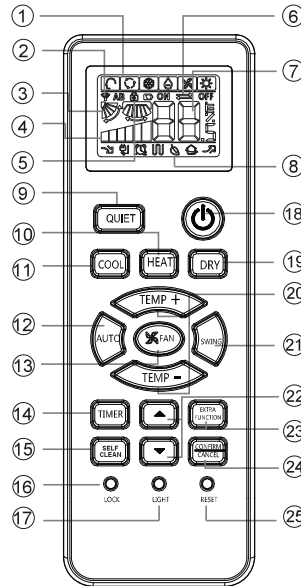

### 8. Additional functions display

Operation mode	QUIET SLEEP	Supplemented electrical heating	HEALTH TURBO
Remote controller			

- 9. QUIET button
- 10. HEAT button
- 11. COOL button
- 12. AUTO button
- 13. FAN SPEED button
- 14. TIMER button
- 15. SELF CLEAN button
- 16. LOCK button  
Used to lock buttons and LCD display
- 17. LIGHT button  
Control the lightening and extinguishing of the indoor LED display board.
- 18. POWER ON/OFF button
- 19. DRY button
- 20. TEMP button
- 21. SWING button
- 22. HOUR button
- 23. EXTRA FUNCTION button

Function: Sleeping→→Health→→Healthy airflow position1→→Healthy airflow position 2 →→ Turbo →→Air sending →→A-B yard

24.CANCEL/CONFIRM button  
Function: Setting and cancel to the timer and other additional functions.

25. RESET button  
When the remote controller appears abnormal, use a sharp pointed article to press this button to reset the remote.

### 1. Mode display

Operation mode	AUTO	COOL	DRY	FAN	HEAT
Remote controller					

- 2. Signal sending display
- 3. SWING display
- 4. FAN SPEED display

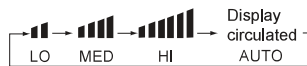

- 5. LOCK display
- 6. TIMER OFF display
- 7. TEMP display

Healthy function is not available for some units.

## Loading of the battery

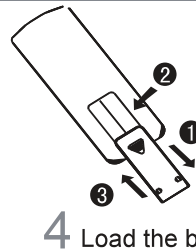

- 1 Remove the battery cover;
- 2 Load the batteries as illustrated. 2 R-03 batteries, resetting key (cylinder);
- 3 Be sure that the loading is in line with the "+" + "-" ;
- 4 Load the battery, then put on the cover again.

### Note:

- The distance between the signal transmission head and the receiver hole should be within 7m without any obstacle as well.
- When electronic-started type fluorescent lamp or change-over type fluorescent lamp or wireless telephone is installed in the room, the receiver is apt to be disturbed in receiving the signals, so the distance to the indoor unit should be shorter.
- Full display or unclear display during operation indicates the batteries have been used up. Please change batteries.
- If the remote controller can't run normally during operation, please remove the batteries and reload several minutes later.

### Hint:

Remove the batteries in case won't be in use for a long period. If there is any display after taking-out, just press reset key.

# Operation

## Base Operation

Remote controller

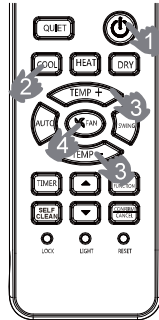

English

### 1. Unit start

Press ON/OFF on the remote controller, unit starts.

### 2. Select operation mode

COOL button: Cooling mode  
HEAT button: Heating mode  
DRY button: Dehumidify mode

### 3. Select temp. setting

Press TEMP+ / TEMP- button

TEMP+ Every time the button is pressed, temp. setting increase 1°C, if kept depressed, it will increase rapidly

TEMP- Every time the button is pressed, temp. setting decrease 1°C, if kept depressed, it will decrease rapidly

Select a desired temperature.

### 4. Fan speed selection

Press FAN button. For each press, fan speed changes as follows:

Remote controller:

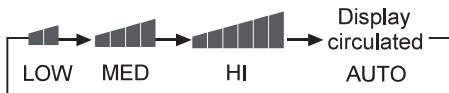

Air conditioner is running under displayed fan speed. When FAN is set to AUTO, the air conditioner automatically adjusts the fan speed according to room temperature.

Operation Mode	Remote Controller	Note
AUTO		Under the mode of auto operation, air conditioner will automatically select Cool or Heat operation according to room temperature. When FAN is set to AUTO the air conditioner automatically adjusts the fan speed according to room temperature.
COOL		Cooling only unit do not have displays and functions related with heating
DRY		In DRY mode, when room temperature becomes lower than temp. setting + 2°C, unit will run intermittently at LOW speed regardless of FAN setting.
HEAT		In HEAT mode, warm air will blow out after a short period of the time due to cold-draft prevention function. When FAN is set to AUTO, the air conditioner automatically adjusts the fan speed according to room temperature.
FAN		In FAN operation mode, the unit will not operate in COOL or HEAT mode but only in FAN mode, AUTO is not available in FAN mode. And temp. setting is disabled. In FAN mode, sleep operation is not available.

## Emergency operation and test operation

### Emergency Operation:

- Use this operation only when the remote controller is defective or lost, and with function of emergency running, air conditioner can run automatically for a while.
- When the emergency operation switch is pressed, the "Pi" sound is heard once, which means the start of this operation.
- When power switch is turning on for the first time and emergency operation starts, the unit will run automatically in the following modes:

Room temperature	Designated temperature	Timer mode	Fan speed	Operation mode
Above 24°C	24°C	No	AUTO	COOL
Below 24°C	24°C	No	AUTO	HEAT

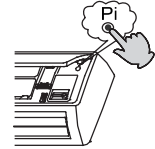

- It is impossible to change the settings of temp. and fan speed, It is also not possible to operate in timer or dry mode.

### Test operation:

Test operation switch is the same as emergency switch.

- Use this switch in the test operation when the room temperature is below 16°C, do not use it in the normal operation.
- Continue to press the test operation switch for more than 5 seconds. After you hear the "Pi" sound twice, release your finger from the switch: the cooling operation starts with the air flow speed "HI".
- Under this operation mode, the fan motor of indoor unit will run in high speed.

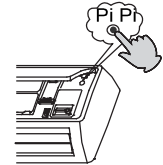

## Air Flow Direction Adjustment

### 1. Vertical flap

- Pos.1
- Pos.2
- Pos.3
- Pos.4 (Autoswing)
- Pos.5

### Remote controller

COOL/DRY/AUTO (Initial state):

HEAT (Initial state):



(no)

### 2. Press button. changes as follows: Pos.4

Press button again, vertical flap will stop over present position, the swing function will be cancelled.

### 3. Press button to choose the Pos.2 and Pos.3.

### 4. Left and right air flow adjustment (manual)

Move the vertical blade by a knob on air conditioner to adjust left and right direction referring to Fig.



- When adjusting the flap by hand, turn off the unit.
- When humidity is high, condensate water might occur adjusted to left or at air outlet if all vertical louvers are right.
- It is advisable not to keep horizontal flap at downward position for a long time in COOL or DRY mode, otherwise, condensate water might occur.

Note:

When restart after remote turning off, the remote controller will automatically memorize the previous set swing position.

# Operation

## Sleep Operation

Press **EXTRA FUNCTION** button to enter additional options, when cycle display to  ,  will flash. And then press **CONFIRM/CANCEL** enter to sleep function.



### Operation Mode

#### 1. In COOL, DRY mode

1 hours after SLEEP mode starts, temp. will become 1°C higher than temp. setting. After another 1 hours, temp. rises by 1°C further. The unit will run for further 6 hours then stops. Temp. is higher than temp. setting so that room temperature won't be too low for your sleep.

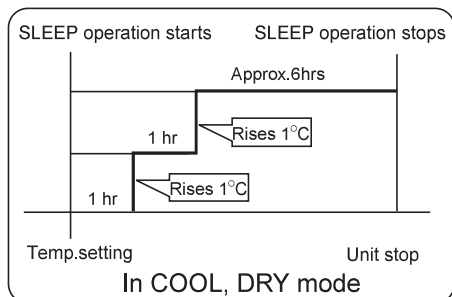

#### 2. In HEAT mode

1 hours after SLEEP mode starts, temp will become 2°C lower than temp. setting. After another 1 hours, temp decrease by 2°C further. After more another 3 hours, temp. rises by 1°C further. The unit will run for further 3 hours then stops. Temp. is lower than temp. setting so that room temperature won't be too high for your sleep.

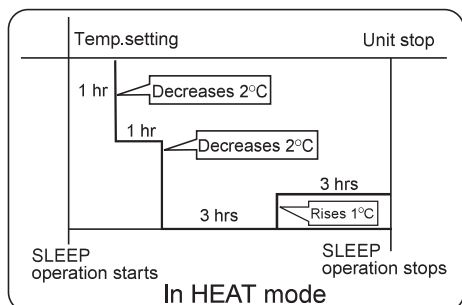

#### 3. In AUTO mode

The unit operates in corresponding sleep mode adapted to the automatically selected operation mode.

#### 4. In FAN mode

It has no SLEEP function.

#### 5. Set the wind speed change when sleeping

If the wind speed is high or middle before setting for the sleep, set for lowering the wind speed after sleeping. If it is low wind, no change.



### Note

When TIMER function is set, the sleeping function can't be set up. After the sleeping function is set up, if user resets TIMER function, the sleeping function will be cancelled; the machine will be in the state of timing-on.

## TURBO/QUIET Operation

### (1) TURBO Operation

When you need rapid heating or cooling, you can use this function.

Press **EXTRA FUNCTION** button to enter additional options, when cycle display to   will flash, and then press **CONFIRM/CANCEL** enter to turbo function. When cancel the function, please enter additional options again and to cancel turbo function.

### (2) QUIET Operation



You can use this function when silence is needed for rest or reading. Press QUIET button, the remote controller will show , and then achieve to the quiet function. Press again this QUIET button, the quiet function will be cancelled.

### Note :

During TURBO operation, in rapid HEAT or COOL mode, the room will show inhomogeneous temperature distribution. Long period QUIET operation will cause effect of not too cool or not too warm.

## HEALTH Operation

(This function is unavailable on some models.)

Press **EXTRA FUNCTION** button to enter additional options, when cycle display to ,  will flash. And then press **CONFIRM/CANCEL** enter to health function.

The anion generator in the air conditioner can generate a lot of anion effectively balance the quantity of positive and negative ions in the air and also to kill bacteria and speed up the dust sediment in the room and finally clean the air in the room.

# Operation

## Timer On/Off On-Off Operation

1. After unit starts, select your desired operation mode.
2. Press TIMER button to change TIMER mode. Every time the button is pressed, display changes as follows:  
Remote controller:

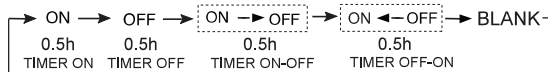

Then select your desired TIMER mode (TIMER ON or TIMER OFF or TIMER ON-OFF). " ON "or" OFF "will flash.

3. Press ▼ / ▲ button to set time.

- ▲ Press the button for each time, setting time in the first 12 hours increased by 0.5 hour every time, after 12 hours, increased by 1 hour every time.
- ▼ Press the button for each time, setting time in the first 12 hours decreased by 0.5 hour every time, after 12 hours, decreased by 1 hour every time. It can be adjusted within 24 hours.

4. Confirm timer setting

After adjust the time, press button and confirm the time ON or OFF button will not flash any more.

5. Cancel timer setting

Press the timer button by times until the time display eliminated.

Hints:

After replacing batteries or a power failure happens, time setting should be reset.

According to the Time setting sequence of TIMER ON or TIMER OFF, either Start-Stop or Stop-Start can be achieved.

## Healthy airflow Operation

1. Press to starting

Setting the comfort work conditions.

2. The setting of healthy airflow function

Press button to enter additional options, Press this button continuously, the louvers location will cycle between in the following three locations, to choose the swing location what you needed, and then press button to confirm.



3. The cancel of the healthy airflow function

Press button to enter additional options, Press this button continuously, the louvers location will cycle between in the following three locations again, and then press button to cancel.

Notice: Do not direct the flap by hand. Otherwise, the grille will run incorrectly. If the grille is not run correctly, stop for a minute and then start, adjusting by remote controller.

Note:

1. After setting the healthy airflow function, the position grill is fixed.
2. In heating, it is better to select the mode.
3. In cooling, it is better to select the mode.
4. In cooling and dry, using the air conditioner for a long time under the high air humidity, condensate water may occur at the grille .

## EUROPEAN REGULATIONS CONFORMITY FOR THE MODELS

Climate:T1 Voltage:230V

CE

All the products are in conformity with the following

European provision:

2014/53/EU(REG) 2014/517/EU(F-GAS) 2010/30/EU(ENERGY)

2009/125/EC(ENERGY) 2006/1907/EC(REACH)

RoHS

The products are fulfilled with the requirements in the directive 2011/65/EU of the European parliament and of council on the Restriction of the use of Certain Hazardous Substances in Electrical and Electronic Equipment (EU RoHS Directive)

WEEE

In accordance with the directive 2012/19/EU of the European parliament, herewith we inform the consumer about the disposal requirements of the electrical and electronic products.

DISPOSAL REQUIREMENTS:



Your air conditioning product is marked with this symbol. This means that electrical and electronic products shall not be mixed with unsorted household waste. Do not try to dismantle the system yourself : the dismantling of the air

conditioning system, treatment of the refrigerant, of oil and of other part must be done by a qualified installer in accordance with relevant local and national legislation. Air conditioners must be treated at a specialized treatment facility for reuse, recycling and recovery. By ensuring this product is disposed of correctly, you will help to prevent potential negative consequences for the environment and human health. Please contact the installer or local authority for more information. Battery must be removed from the remote controller and disposed of separately in accordance with relevant local and national legislation.

Wi-Fi

-Wireless maximum transmit power (20dBm)

-Wireless operating frequency range (2400~2483.5MHz)

## IMPORTANT INFORMATION REGARDING THE REFRIGERANT USED

This product contains fluorinated greenhouse gases . Do not vent into the atmosphere.

Refrigerant type:R32

GWP\* value:675

GWP=global warming potential

Please fill in with indelible ink,

- 1 the factory refrigerant charge of the product
- 2 the additional refrigerant amount charged in the field and
- 1+2 the total refrigerant charge

on the refrigerant charge label supplied with the product.

The filled out label must be adhered in the proximity of the product charging port (e.g. onto the inside of the stop valve cover).

A contains fluorinated greenhouse gases .

B factory refrigerant charge of the product: see unit name plate C

additional refrigerant amount charged in the field

D total refrigerant charge

E outdoor unit

F refrigerant cylinder and manifold for charging



# Operation

## SELF-CLEAN Operation

### ◆ Functional description:

the purpose of this function is to clean the evaporator.

### ◆ Entry and exit:

Press SELF CLEAN button to enter this function, then it will display "CL" on the panel of the indoor unit and also on the remote controller. Maximum running time not more than 21 minutes, this function will exit automatically with the "Pi" sound twice, then the unit return to original state. Under operation process of SELF CLEAN, press the button repeatedly is invalid and cannot exit, please press the "power" button or swift to other mode to exit.

### ◆ Note:

- 1.This function is invalid in timer / sleep mode.
- 2.After this mode starts, the air volume may reduce or even have no airflow,or even cold airflow blowing.
- 3.It is normal if the unit make some sound like expand with heat and contract with cold.
4. The "CL" display time may last differently on the remote controller and panel.
- 5.If the outside ambient temperature below zero, error code "F25" may be occurred during self-cleaning operation , which is normal protection, please turn off the power and to restart after 10 seconds .
- 6.The best condition to run this mode: the temperature is 20℃~27℃ and the humidity is 35%~60% in the door, the temperature is 25℃~38℃ (cooling season) out the door.
- 7.It is hard to frost if the air is too dry(humidity < 20%). and if the humidity is too high(humidity > 70%),the condensate water may increase, which may move away some frost.

# Indoor Unit Installation

## Necessary Tools for Installation

- Driver
- Nipper
- Hacksaw
- Hole core drill
- Spanner(17,19 and 26mm)
- Gas leakage detector or soap-and-water solution
- Torque wrench (17mm,22mm,26mm)
- Pipe cutter
- Flaring tool
- Knife
- Measuring tape
- Reamer

## Power Source

- Before inserting power into receptacle, check the voltage without fail.
- The power supply is the same as the corresponding nameplate.
- Install an exclusive branch circuit of the power.
- A receptacle shall be set up in a distance where the power cable can be reached. Do not extend the cable by cutting it.

## Selection of Installation Place

English

- Place, robust not causing vibration, where the body can be supported sufficiently.
- Place, not affected by heat or steam generated in the vicinity, where inlet and outlet of the unit are not disturbed.
- Place, possible to drain easily, where piping can be connected with the outdoor unit.
- Place, where cold air can be spread in a room entirely.
- Place, nearby a power receptacle, with enough space around.
- Place where the distance of more than 1m from televisions, radios, wireless apparatuses and fluorescent lamps can be left.
- In the case of fixing the remote controller on a wall, place where the indoor unit can receive signals when the fluorescent lamps in the room are lightened.

## Drawing for the installation of indoor units

The models adopt HFC refrigerant R32.

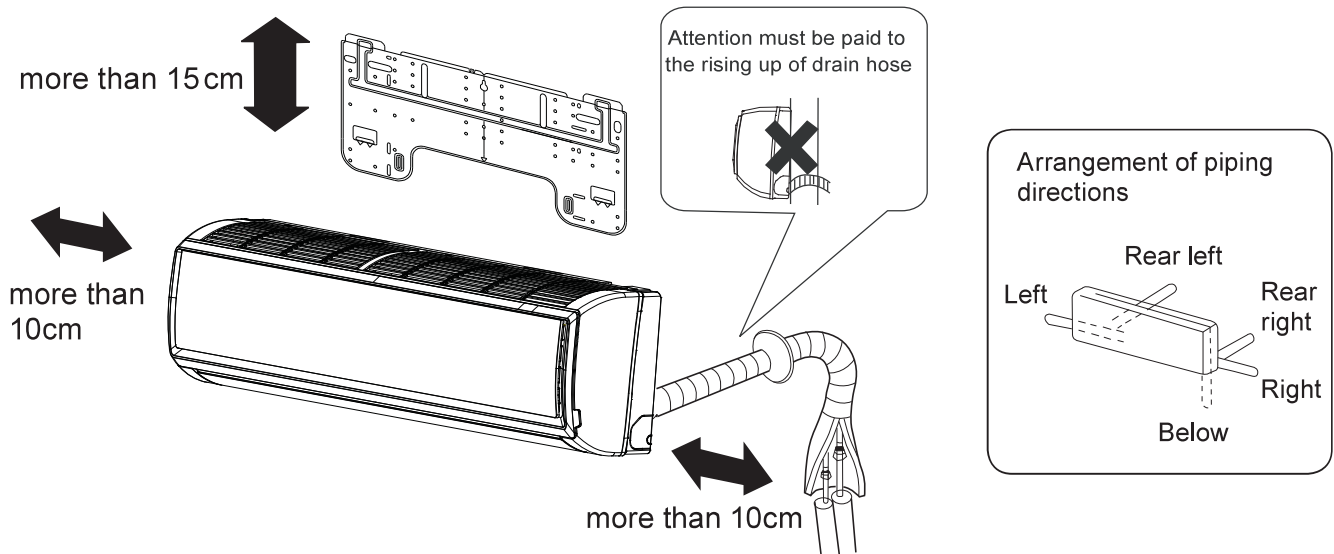

The distance between the indoor unit and the floor should be more than 2m.  
Please be subject to the actual product purchased, the above picture is just for your reference.



If using the left side drain pipe, make sure the hole is got through.

# Indoor Unit Installation

## 1 Fitting of the Mounting Plate and Positioning of the wall Hole

When the mounting plate is first fixed

1. Carry out, based on the neighboring pillars or lintels, a proper leveling for the plate to be fixed against the wall, then temporarily fasten the plate with one steel nail.
2. Make sure once more the proper level of the plate, by hanging a thread with a weight from the central top of the plate, then fasten securely the plate with the attachment steel nail.
3. Find the wall hole location A/C using a measuring tape

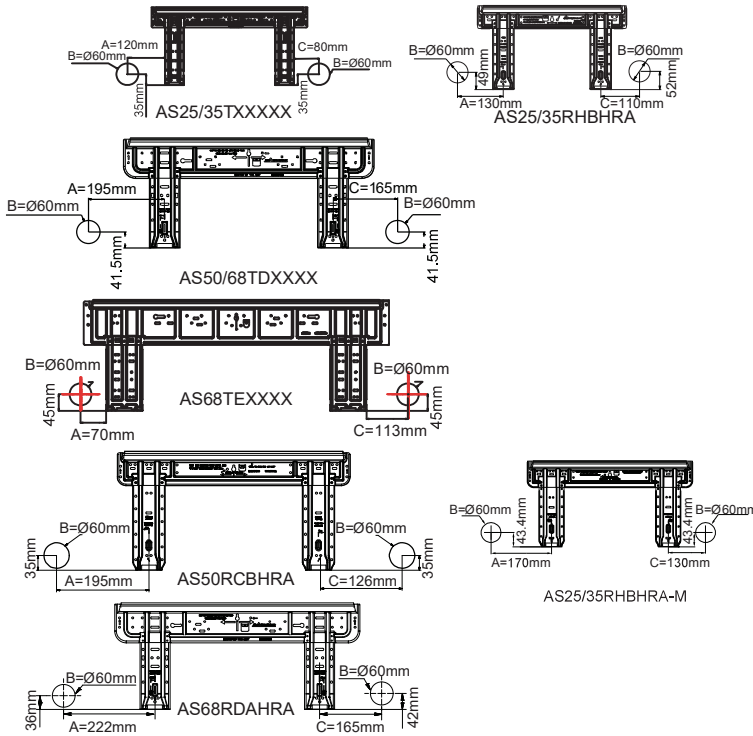

When the mounting plate is fixed side bar and lintel

- Fix to side bar and lintel a mounting bar, which is separately sold, and then fasten the plate to the fixed mounting bar.
- Refer to the previous article, "When the mounting plate is first fixed", for the position of wall hole.

## 2 Making a Hole on the Wall and Fitting the Piping Hole Cover

- Make a hole of 60 mm in diameter, slightly descending to outside the wall
- Install piping hole cover and seal it off with putty after installation

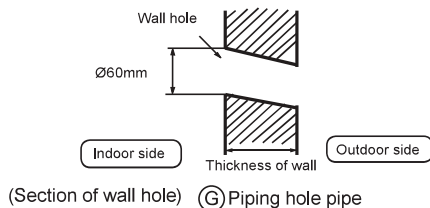

## 3 Installation of the Indoor Unit

Drawing of pipe

[ Rear piping ]

- Draw pipes and the drain hose, then fasten them with the adhesive tape

[ Left • Left-rear piping ]

- In case of left side piping, cut away, with a nipper, the lid for left piping.
  - In case of left-rear piping, bend the pipes according to the piping direction to the mark of hole for left-rear piping which is marked on heat insulation materials.
1. Insert the drain hose into the dent of heat insulation materials of indoor unit.
  2. Insert the indoor/outdoor electric cable from backside of indoor unit, and pull it out on the front side, then connect them.
  3. Coat the flaring seal face with refrigerant oil and connect pipes. Cover the connection part with heat insulation materials closely, and make sure fixing with adhesive tape

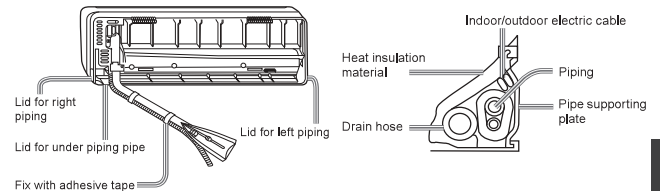

- Indoor/outdoor electric cable and drain hose must be bound with refrigerant piping by protecting tape.

[ Other direction piping ]

- Cut away, with a nipper, the lid for piping according to the piping direction and then bend the pipe according to the position of wall hole. When bending, be careful not to crash pipes.
- Connect beforehand the indoor/outdoor electric cable, and then pull out the connected to the heat insulation of connecting part specially.

Fixing the indoor unit body

- Hang surely the unit body onto the upper notches of the mounting plate. Move the body from side to side to verify its secure fixing.
- In order to fix the body onto the mounting plate, hold up the body aslant from the underside and then put it down perpendicularly.

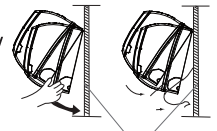

Unloading of indoor unit body

- When you unload the indoor unit, please use your hand to arise the body to leave a agraffe, then lift the bottom of the body outward slightly and lift the unit aslant until it leaves the mounting plate.

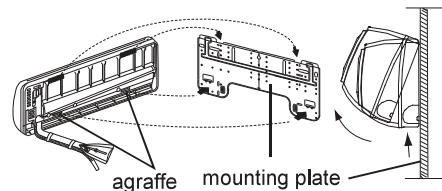

## 4 Connecting the indoor/outdoor Electric Cable

Removing the wiring cover

- Remove terminal cover at right bottom corner of indoor unit, then take off wiring cover by removing its screws.

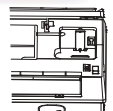

## When connecting the cable after installing the indoor unit

1. Insert from outside the room cable into left side of the wall hole, in which the pipe has already existed.
2. Pull out the cable on the front side, and connect the cable making a loop.

## When connecting the cable before installing the indoor unit

- Insert the cable from the back side of the unit, then pull it out on the front side.
- Loosen the screws and insert the cable ends fully into terminal block, then tighten the screws.
- Pull the cable slightly to make sure the cables have been properly inserted and tightened.
- After the cable connection, never fail to fasten the connected cable with the wiring cover.

English

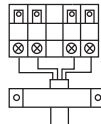
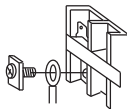
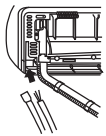

To Outdoor unit

### Note:

When connecting the cable, confirm the terminal number of indoor and outdoor units carefully. If wiring is not correct, proper operation can not be carried out and will cause defect.

Connecting wiring	4G1.0mm <sup>2</sup>
-------------------	----------------------

1. If the supply cord is damaged, it must be replaced by the manufacturer or its service agent or a similar qualified person. The type of connecting wire is H07RN-F.
2. If the fuse on PC board is broken please change it with the type of T.3.15A/250VAC (Indoor).
3. The wiring method should be in line with the local wiring standard.
4. After installation, the power plug should be easily reached.
5. A breaker should be incorporated into fixed wiring. The breaker should be all-pole switch and the distance between its two contacts should be not less than 3mm.
6. AS35TAMHRA Connecting wiring 4G1.5mm<sup>2</sup>

## 5 Power Source Installation

- The power source must be exclusively used for air conditioner.
- In the case of installing an air conditioner in a moist place, please install an earth leakage breaker.
- For installation in other places, use a circuit breaker as far as possible.

## 6 Cutting and Flaring Work of Piping

- Pipe cutting is carried out with a pipe cutter and burs must be removed.
- After inserting the flare nut, flaring work is carried out.

	Flare tool	Conventional flare tool	
		clutch-type	Wing-nut type (Imperial-type)
A	0~0.5mm	1.0~1.5mm	1.5~2.0mm

Flare tooling die

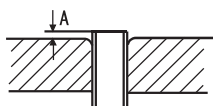

1. Cut pipe



3. Insert the flare nut



2. Remove burs



4. Flare pipe



Correct	Incorrect				
	Lean	Damage of flare	Crack	Partial	Too outside

## 7 On Drainage

- Please install the drain hose so as to be downward slope without fail.
- Please don't do the drainage as shown below.

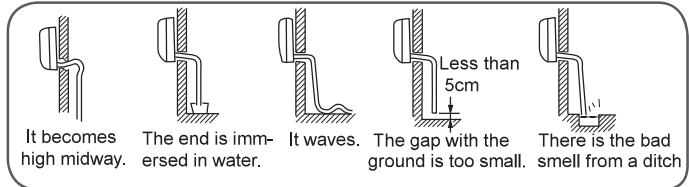

- Please pour water in the drain pan of the indoor unit, and confirm that drainage is carried out surely to outdoor.
- In case that the attached drain hose is in a room, please apply heat insulation to it without fail.

## 8 On Drainage

Code indication	Trouble description	Analyze and diagnose
E1	Room temperature sensor failure	Faulty connector connection; Faulty thermistor;
E2	Heat-exchange sensor failure	Faulty PCB;
E4	Indoor EEPROM error	Faulty EEPROM data; Faulty EEPROM; Faulty PCB;
E7	Communication fault between indoor and outdoor units	Indoor unit- outdoor unit signal transmission error due to wiring error; Faulty PCB;
E14	Indoor fan motor malfunction	Operation halt due to breaking of wire inside the fan motor; Operation halt due to breaking of the fan motor lead wires; Detection error due to faulty indoor unit PCB;

## 9 Check for Installation and Test Run

- Please kindly explain to our customers how to operate through the instruction manual.







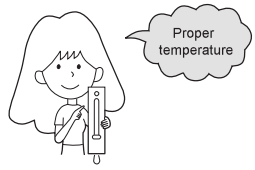
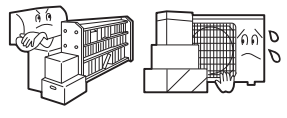

### Check Items for Test Run

Put check mark ✓ in boxes

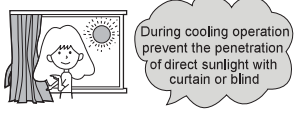
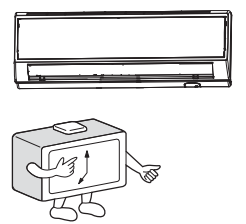
- Gas leak from pipe connecting?
- Heat insulation of pipe connecting?
- Are the connecting wirings of indoor and outdoor firmly inserted to the terminal block?
- Is the connecting wiring of indoor and outdoor firmly fixed?
- Is drainage securely carried out?
- Is the earth line securely connected?
- Is the indoor unit securely fixed?
- Is power source voltage abided by the code?
- Is there any noise?
- Is the lamp normally lighting?
- Are cooling and heating (when in heat pump) performed normally?
- Is the operation of room temperature regulator normal?



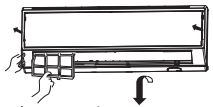

# Maintenance

## For Smart Use of The Air Conditioner

<p>Setting of proper room temperature</p> 	<p>Do not block the air inlet or outlet</p> 	<p>Remote Controller</p>  <p>Do not use water, wipe the controller with a dry cloth. Do not use glass cleaner or chemical cloth.</p>	<p>Indoor Body</p>  <p>wipe the air conditioner by using a soft and dry cloth. For serious stains, use a neutral detergent diluted with water. Wring the water out of the cloth before wiping, then wipe off the detergent completely.</p>
<p>Close doors and windows during operation</p> 	<p>Use the timer effectively</p> 	<p>Do not use the following for cleaning</p>  <p>Gasoline, benzene, thinner or cleanser may damage the coating of the unit. Hot water over 40°C(104°F) may cause discoloring or deformation.</p>	
<p>If the unit is not to be used for a long time, turn off the power supply main switch.</p> 	<p>Use the louvers effectively</p> 	<p><b>Air Filter cleaning</b></p> <ol style="list-style-type: none"> <li>1 Open the inlet grille by pulling it upward.</li> <li>2 Remove the filter. Push up the filter's center tab slightly until it is released from the stopper, and remove the filter downward.</li> <li>3 Clean the filter. Use a vacuum cleaner to remove dust, or wash the filter with water. After washing, dry the filter completely in the shade.</li> <li>4 Attach the filter. Attach the filter correctly so that the "FRONT" indication is facing to the front. Make sure that the filter is completely fixed behind the stopper. If the right and left filters are not attached correctly, that may cause defects.</li> <li>5 Close the inlet grille.</li> </ol>  	

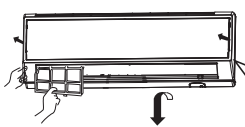
English

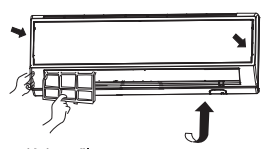
## Replacement of Air Purifying Filter

<p><b>1. Open the Inlet Grille</b> Prop up the inlet grille by using a small device named grille-support which located in the right side of the indoor unit.</p>  <p><b>2. Detach the standard air filter</b> Slide the knob slightly upward to release the filter, then withdraw it.</p>  <p>Detach old Air Purifying Filter</p> 	<p><b>4. Attach the standard air filter</b> (Necessary installation)</p>  <p><b>ATTENTION:</b> The white side of the photocatalyst air purifying filter face outside, and the black side face the unit. The green side of the bacteria-killing medium air purifying filter face outside, and the white side face the unit.</p> <p><b>5. Close the Inlet Grille</b> Close the Grille surely</p> <p><b>NOTE:</b></p> <ul style="list-style-type: none"> <li>• The photocatalyst air purifying filter will be solarized in fixed time. In normal family, it will be solarized every 6 months.</li> <li>• The bacteria-killing medium air purifying filter will be used for a long time, no need for replacement. But in the period of using them, you should remove the dust frequently by using vacuum cleaner or flapping them lightly, otherwise, its performance will be affected.</li> <li>• Please keep the bacteria-killing medium air purifying filter in the cool and dry conditions avoid long time directly sunshine when you stop using it, or its ability of sterilization will be reduced.</li> </ul>
<p><b>3. Attach Air Purifying Filter</b> Put air purifying filter appliances into the right and left filter frames.</p> 	

# Cautions

## ⚠ WARNING

Please call Sales/Service Shop for the Installation.

Do not attempt to install the air conditioner by yourself because improper works may cause electric shock, fire, water leakage.

## ⚠ WARNING

When abnormality such as burnt-smell found, immediately stop the operation button and contact sales shop.

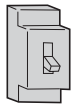

OFF



⚠  
STRICT  
ENFORCEMENT

Use an exclusive power source with a circuit breaker

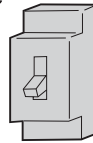

Check proper installation of the drainage securely



STRICT  
ENFORCEMENT

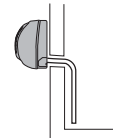

Connect power supply cord to the outlet completely



STRICT  
ENFORCEMENT

Use the proper voltage



STRICT  
ENFORCEMENT

1. Do not use power supply cord extended or connected in halfway  
2. Do not install in the place where there is any possibility of inflammable gas leakage around the unit.  
3. Do not get the unit exposed to vapor or oil steam.



PROHIBITION

Do not use power supply cord in a bundle.

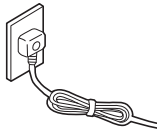

PROHIBITION

Take care not to damage the power supply cord.



PROHIBITION

Do not insert objects into the air inlet or outlet.

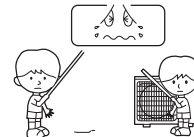

PROHIBITION

Do not start or stop the operation by disconnecting the power supply cord and so on.

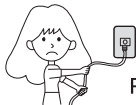

PROHIBITION

Do not channel the air flow directly at people, especially at infants or the aged.



PROHIBITION

Do not try to repair or reconstruct by yourself.

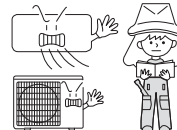

Connect the earth cable.

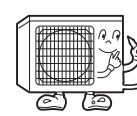

earthing

## ⚠ CAUTION

Do not use for the purpose of storage of food, art work, precise equipment, breeding, or cultivation.



PROHIBITION

Take fresh air occasionally especially when gas appliance is running at the same time.

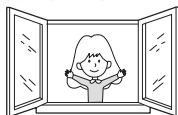

STRICT  
ENFORCEMENT

Do not operate the switch with wet hand.

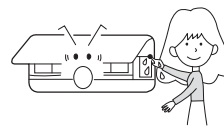

PROHIBITION

Do not install the unit near a fireplace or other heating apparatus.

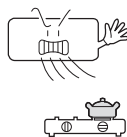

PROHIBITION

Check good condition of the installation stand

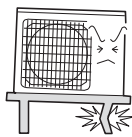

PROHIBITION

Do not pour water onto the unit for cleaning

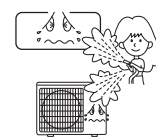

PROHIBITION

Do not place animals or plants in the direct path of the air flow

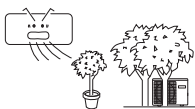

PROHIBITION

Do not place any objects on or climb on the unit.

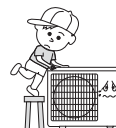

PROHIBITION

Do not place flower vase or water containers on the top of the unit.





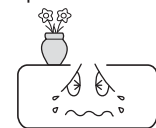

PROHIBITION



# Trouble shooting

Before asking for service, check the following first.

	Phenomenon	Cause or check points
Normal Performance inspection	The system does not restart immediately. 	<ul style="list-style-type: none"> <li>When unit is stopped, it won't restart immediately until 3 minutes have elapsed to protect the system.</li> <li>When the electric plug is pulled out and reinserted, the protection circuit will work for 3 minutes to protect the air conditioner.</li> </ul>
	Noise is heard 	<ul style="list-style-type: none"> <li>During unit operation or at stop, a swishing or gurgling noise may be heard. At first 2-3 minutes after unit start, this noise is more noticeable. (This noise is generated by refrigerant flowing in the system.)</li> <li>During unit operation, a cracking noise may be heard. This noise is generated by the casing expanding or shrinking because of temperature changes.</li> <li>Should there be a big noise from air flow in unit operation, air filter may be too dirty.</li> </ul>
	Smells are generated.	<ul style="list-style-type: none"> <li>This is because the system circulates smells from the interior air such as the smell of furniture, paint, cigarettes.</li> </ul>
	Mist or steam are blown out. 	<ul style="list-style-type: none"> <li>During COOL or DRY operation, indoor unit may blow out mist. This is due to the sudden cooling of indoor air.</li> </ul>
	In dry mode, fan speed can't be changed.	<ul style="list-style-type: none"> <li>In DRY mode, when room temperature becomes lower than temp. setting+2 °C, unit will run intermittently at LOW speed regardless of FAN setting.</li> </ul>
Multiple check		<ul style="list-style-type: none"> <li>Is power plug inserted?</li> <li>Is there a power failure?</li> <li>Is fuse blownout?</li> </ul>
	Poor cooling 	<ul style="list-style-type: none"> <li>Is the air filter dirty? Normally it should be cleaned every 15 days.</li> <li>Are there any obstacles before inlet and outlet?</li> <li>Is temperature set correctly?</li> <li>Are there some doors or windows left open?</li> <li>Is there any direct sunlight through the window during the cooling operation? (Use curtain)</li> <li>Are there too much heat sources or too many people in the room during cooling operation?</li> </ul>

# Cautions

- Do not obstruct or cover the ventilation grille of the air conditioner. Do not put fingers or any other things into the inlet/outlet and swing louver.
- This appliance is not intended for use by persons (including children) with reduced physical, sensory or mental capabilities or lack of experience and knowledge, unless they have been given supervision or instruction concerning use of appliance by person responsible for their safety. Children should be supervised to ensure that they do not play with the appliance.

## Specifications

- The refrigerating circuit is leak-proof.

## The machine is adaptive in following situation

1. Applicable ambient temperature range:

Cooling	Indoor	Maximum: D.B/W.B 35°C/24°C Minimum: D.B/W.B 21°C/15°C
	Outdoor	Maximum: D.B/W.B 43°C/26°C Minimum: D.B -15°C
Heating	Indoor	Maximum: D.B 27°C Minimum: D.B 10°C
	Outdoor	Maximum: D.B/W.B 24°C/18°C Minimum: D.B/W.B -7°C/-8°C
	Outdoor (INVERTER)	Maximum: D.B/W.B 24°C/18°C Minimum: D.B -15°C

- If the power supply cord is damaged, it must be replaced by the manufacturer or its service agent or a similar qualified person.
- If the fuse of indoor unit on PC board is broken, please change it with the type of T. 3.15A/ 250V. If the fuse of outdoor unit is broken, change it with the type of T.25A/250V
- The wiring method should be in line with the local wiring standard.
- After installation, the power plug should be easily reached.
- The waste battery should be disposed properly.
- The appliance is not intended for use by young children or infirm persons without supervision.
- Young children should be supervised to ensure that they do not play with the appliance.
- Please employ the proper power plug, which fit into the power supply cord.
- The power plug and connecting cable must have acquired the local attestation.
- In order to protect the units, please turn off the A/C first, and at least 30 seconds later, cutting off the power.

Address: Haier Industrial Park, Haier Road, Hi-Technology Zone, Qingdao City, Shandong Province, P.R. China

Contacts: TEL +86-532-8893-7937

Website: [www.haierhvac.eu](http://www.haierhvac.eu)